

Article number: 207321M81012ST
Description: E+G Shoulder screw
GN 732.1-M8-10-12-ST

Measures

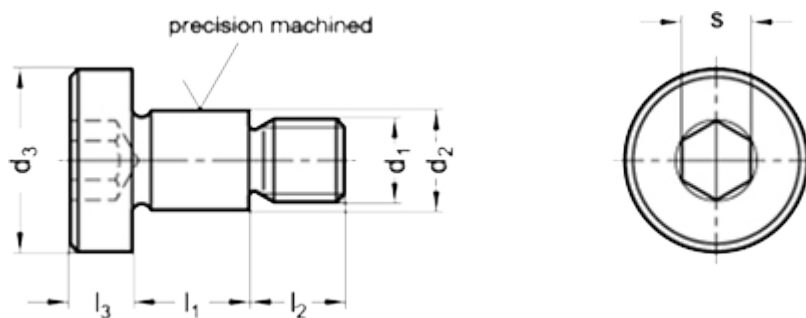

Application example

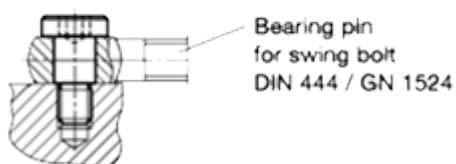

d_1	= M 8
d_2	= 10 -0.05/-0.08
d_3	= 16
$l_1 + 0.20/+0.13$	= 12
l_2	= 11
l_3	= 5
s	= 5
Weight in (g)	= 17